

Elara St
PHOTOBIOREACTORS



SOLARIS
BIOTECH SOLUTIONS

STIRRED AUTOCLAVABLE PHOTOBIOREACTORS

ELARA ST

ELARA ST photobioreactor series is ideal for phototrophic organisms such as moss, microalgae, bacteria and plant cells. The light spectrum and intensity is adjustable 0-100% up to 3000 $\mu\text{mol}(\text{photon})/\text{m}^2$.



ELARA ST typical applications includes the following:

- Education & Basic research
- Scale-up and scale-down studies
- Process development and optimization

ELARA ST can be used for:

- Algae
- Phototrophic bacteria
- Plant cells

**INNOVATIVE
SOLUTION**
to improve your
microalgae culture

**WHY TO
INVEST**
IN THIS PRODUCT

High power
LED lighting,
spectrum selectable
and
dimnable 0-100%

FLEXIBILITY

The fully removable light
module allows to use Elara
as a traditional fermenter

Benefits

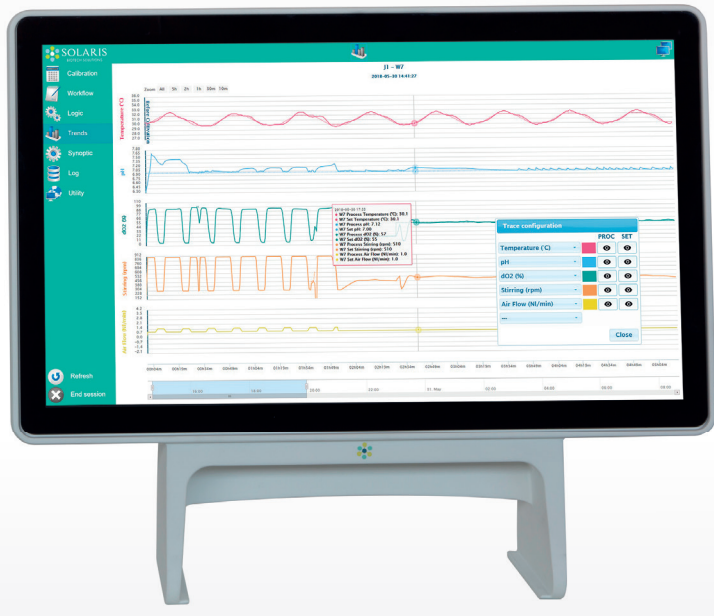
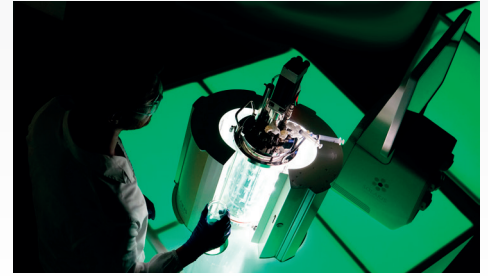
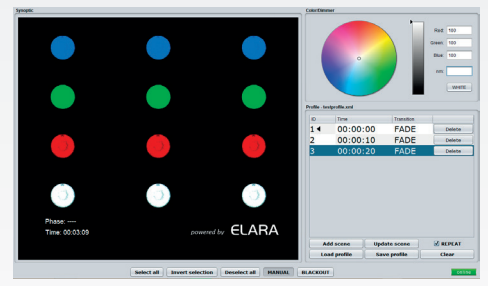

24" touch HMI.

Different gas mixing strategies with up to 5 TMFC

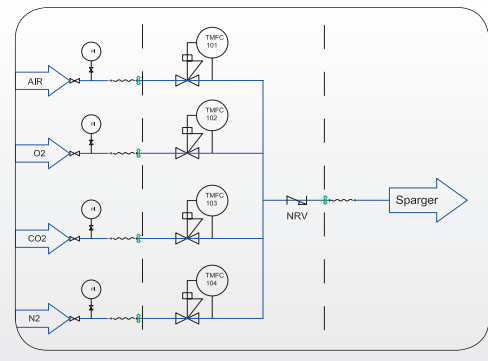

Fully removable and cleanable jacket

Automatic and manual control of RBW light intensity and circadian cycle simulation

Powerful/ Accurate **brushless motor**, from 1 to 2000 RPM. Online absorbed Torques (Nm) and Power (W) measurements obtaining an indirect density indication of the culture broth.

Modbus Digital sensors



LEDA safe sterile sampling system
The needle free connector is designed to reduce the risk of contamination during sampling.
The sterile combination of a syringe (3-5-10-30 ml) and a non return valve guarantees the sterility after sampling until the next use.



Safety: pressure relief valve included in each unit.

Compact and modular PCS

N.4 assignable Watson Marlow pumps in entry level

Additional External modular box:
OD, dCO2, weight, thermobox, peristaltic pumps

Modbus Digital sensors

Why a digital sensor?

Digital sensors (including Cell Density products) have been integrated to the Solaris PCS and Leonardo controlling software, giving the user many benefits over traditional analog sensor outputs. Such benefits include a robust communication protocol not susceptible to signal loss, in-software sensor diagnostic information, parallel calibration/batch calibrations and more.



Sensor life traceability

Reducing background noise

GAS MIXING

Hardware and software adaptability are key to enable the best aeration strategy for each process. Thermal mass flow controllers (TMFC) allow precise flow rate control of individual gasses. Up to 5 TMFC's can be configured within each PCS cube and integrated to the controlling software. The powerful software and control platform allows precise cascade adjustment of multiple parameters to manage gas transfer, OTR, kLa, etc.

- n.1 TMFC included in "entry" level system; additional available as optional.
- Various agitator and baffle designs available
- Automatic gas mixing algorithms
- Toro, sintered and other spargers available



USER-FRIENDLY SOFTWARE

Solaris controlling software offers a simply laid out, yet powerful platform for experimental design planning and process control. The graphical user interface enables the intuitive selection and adjustment of control functions. Extracted data is compatible with Window Excel but, in addition, Solaris offers a platform where fermentation data can be easily exported in real time and thus managed. This software is included in the supply and can be installed on an unlimited number of the client's PC or laptops.



Do it parallel: smarter..faster

Leonardo allows intuitive and time-saving parallel operations. Up to 24 independent fermentations/cultivations can be carried out simultaneously.

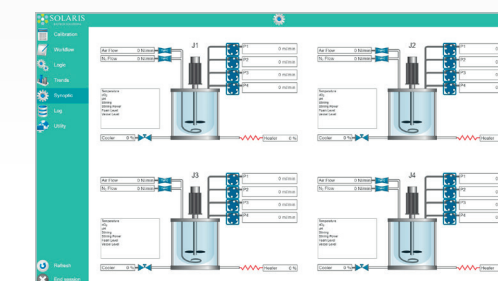

Do it wireless!

Increase mobility: users have the option to access the platform remotely via PC, tablet, phone. Remote access is multi-level password protected.

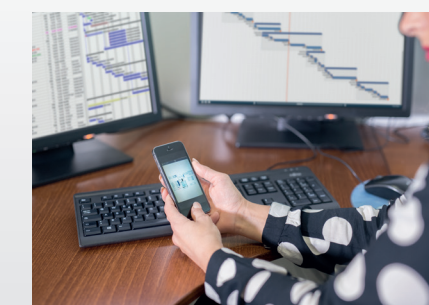
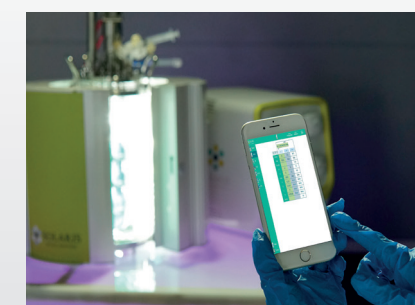

Data sheet

Vessel	
Photobioreactor type	Stirred
Total Volume (liters)	4,00
Ratio D/H	1:3,0
Min. Working Volume (liters)	0,60
Max. Working Volume (liters)	3,00
Max. temperature	135 °C
Operating pressure	< 0,5 bar
Ports	n.1 port, Gas Sparger Input n.1 port, Gas overlay n.1 port, Gas Out n.1 port, Harvesting system n. 1 port, Sampling system n.1 port, Temperature Sensor n.1 port, multi addition (4) needle free connectors n.5 ports, spares probes n.1 port, single addition needle free connector n.1 port, Agitation Group
Design	Borosilicate Glass Jacketed Vessel
Materials	Borosilicate Glass and AISI 316 L
Sensors lenght (mm)	
pH	325
dO ₂	325
Dimensions for autoclave (with Condenser)	
Height (mm)	655
Diameter (mm)	225
Stirring	
Drive	Brushless Motor, Direct Assembly , 1-2000 rpm (bacterial), 1-500 (cell cultures)
Power (P _N)	266 W
Impellers	Select from: Rushtons impellers, Marine Impellers, Pitched blade
Thermoregulation	
Control	PID Control - Accuracy 0,1 °C Thermobox (flat) / water jacketed with electric heaters (stirred vessel)
Gas Control & Gas Mixing	
Sparger and overlay Gas Control	TMFC
Gas Mixing (Air,CO ₂ ,O ₂ ,N ₂)	n.1 TMFC + n. solenoid valves or n° of TMFC
Aeration system	Toro ring or sintered (microbubbling) sparger with 0,2 µm filter
Exhaust	Condenser and 0,2 µm filter
Peristaltic Pumps	
	n.4 Watson Marlow type 114, fixed speed, max. 60 rpm, volumetric flow 0,5-51 ml/min, function assignable from software
	(optional) Watson Marlow type 313 FDM/D, max. speed 350 rpm, volumetric flow 1,5-1750 ml/min, function assignable from software
Controller	
Master Control Module	From 1 to 24 units - 35x37xh36 cm
HMI with Leonardo software	Operate interface 58x15xh48 cm with 24" monitor

Controls

Temperature	
Sensor	PT100
Control system	Measuring resident in Leonardo 3.0 software
Control range	0 - 150°C
pH	
Sensor	Digital sensor
Control system	Measuring resident in Leonardo 3.0 software
Control range	0 - 14
Operation temperature	0 - 130°C
Pressure range	0 - 6 bar
Actuator	Cascade to peristaltic pumps for the addition of acid/base solutions or gas (CO ₂)
dO ₂	
Sensor	Digital Optical sensor
Control system	Measuring resident in Leonardo 3.0 software
Control range	0,05 - 300% air saturation
Operation temperature	-10 - 130°C
Pressure range	0 - 12 bar
Actuator	Cascade to RPM, Gas Control, feedings,ect
Antifoam/Level	
Sensor	Solaris sensor
Control	Measuring resident in Leonardo 3.0 software
Redox (ORP)	
Sensor	Digital sensor
Control system	Measuring resident in Leonardo 3.0 software
Control range	±2000 mV
Operation temperature	- 10 -130°C
Pressure range	≤ 6 bar
Conductivity	
Sensor	Digital sensor
Control system	Measuring resident in Leonardo 3.0 software
Control range	1 - 3000 µS/cm
Operation temperature	0 -130°C
dCO ₂	
Sensor	Analog sensor
Control system	Measuring resident in Leonardo 3.0 software
Control range	0,00-200% saturation
Operation temperature	-20.0-150°C
Pressure range	0 - 4 bar
Weight	
Sensor	Digital Balance
Control	Measuring resident in Leonardo 3.0 software
Peristaltic pumps	
WM 114	10-60 rpm
WM 313 FDM/D	45-350 rpm

Chiller

- Optionally ELARA can be equipped with a chiller for heat removal from your culture minimizing lab water usage
- Using this system you don't need a water supply line in your lab
- Cost-effective cooling of fermenters
- Easy operation
- Refregerant level monitoring



Chiller data sheet	
Working temperature range	-10°C / +40°C
Temperature stability	±0.5
Power consumption	0.7 kW
Filling volume range	2-8 L
Cooling output at 20°C measured with ethanol	0.25-0.60 kW
Cooling output at 10°C measured with ethanol	0.20-0.50 kW
Cooling output at 0°C measured with ethanol	0.15-0.36 kW
Cooling output at -10°C measured with ethanol	0.09-0.15 kW
Pump pressure max.	0.35-1.30 bar
Pump flow max.	16-35 L/min.

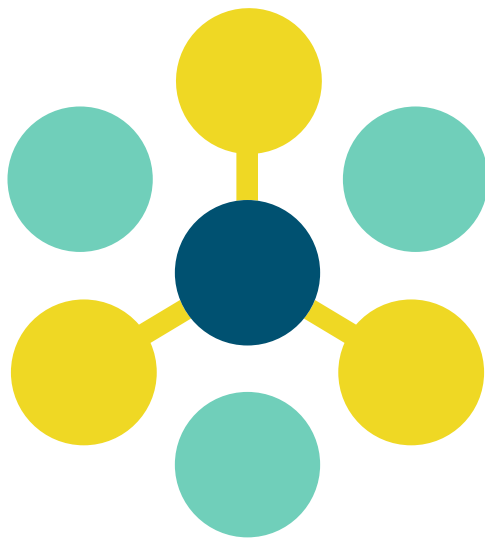

SOLARIS

BIOTECH SOLUTIONS

SOLARIS BIOTECHNOLOGY srl

Via Bachelet, 58 - 46047 Porto Mantovano

Mantova - Italy

Phone: +39 0376 408760

Fax: +39 0376 385108

Email: info@solarisbiotech.com

www.solarisbiotech.com